

Fleck 2510 SXT Digital Water Softener System

Installation Manual



Soft Water System Diagram

Here is a general diagram to guide you through the installation of your new water softening system. Your particular set up may vary. Be sure to set up on a level firm surface near the incoming water source, a drain and a regular un-switched power outlet.

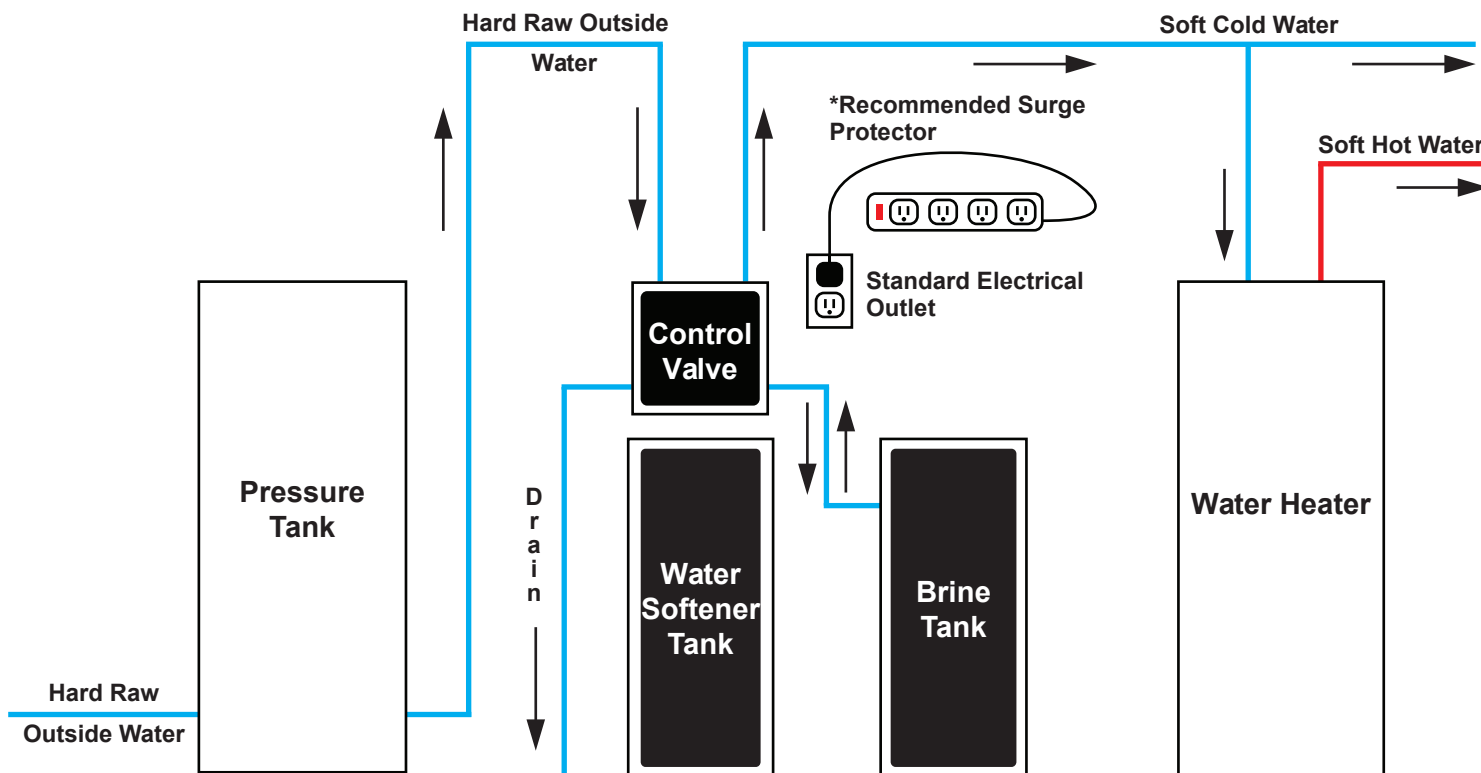

Your Brand New Water Softening System

Hard water problems can be costly. It shortens the life of all your appliances, the pipes in your home and even your clothes because of mineral build up.

Aqua Science's Water Softening Systems help to remove calcium, magnesium, dissolved iron, dissolved manganese, and other heavy metals from water. After your system is running properly, expect high quality water and efficiency for your home's needs.

If you need any help with your set up, please visit our easy to follow, resource rich website, www.aquascience.net or just give us a call at 800-767-8731.

Parts List

Note: **Softening salt sold separately.** Available at most home good stores. We suggest [2 to 3], 40 lb bags. We do sell salt on our website www.aquascience.net if you are having trouble finding it locally.



**Fleck 2510 SXT
Digital Control Valve**

**3/4" or 1" Stainless
Steel Bypass**

**Fiberglass Mineral
Tank**

Riser Tube and Cap

Resin
(See Chart Below for amounts)

**Brine Tank & Brine
Tank Cover**

**Salt Grid Base
w/ (4) Legs***
*(*assembly required)*

Float Tube

Float Tube Assembly

**Brine Hose to Fleck
Valve Connection
Assembly**

Upper Basket
(12" + Tanks Only)

Funnel

Brine Hose
(Colored Tube 3/8")

Backwash Line
(Clear 1/2")

Gravel Sleeve
(for 12x52 Tanks/Systems)

Grain Capacity	Tank Size	Filtration Media
32,000	9x48	1 cubic foot of Resin [1 Bag]
48,000	10x54	1.5 cubic feet of Resin [1 & 1/2 Bags]
64,000	12x52	2 cubic feet of Resin [2 Bags] & 1 sleeve of gravel (as base)

Water Softener Tank Assembly and Valve Installation

NOTE: Please allow a few hours after set up for your system to do its initial processing.



Cover the end of the Riser Tube with the Cap to keep the Resin out and place Riser Tube down the center of the Fiberglass Mineral Tank. Make sure the top of the Riser Tube sits flush with the top of the Fiberglass Mineral Tank. There will be a small dip at the bottom of the tank that the Riser Tube should sit into. You will have to help support the tube to keep it straight. You can center the Riser Tube after you've put in the Resin Beads in the next step.

NOTE: If you have a 12x52 tank/system, you will want to add the sleeve of gravel before adding the Resin.



Use the Funnel to pour the Resin Beads into the Fiberglass Mineral Tank. You have been provided with the appropriate amount of Resin with your system. Refer to the chart at the bottom of the Parts List page to match tank size to proper filtration media amount.

Remove the Cap from the Riser Tube after you're done pouring the Resin into the Tank.

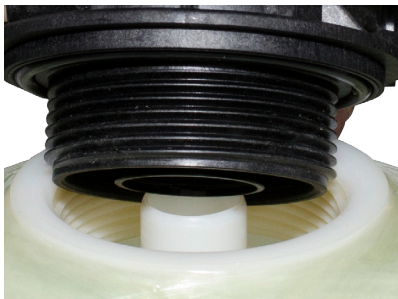

Install the Fleck 2510 SXT Digital Control Valve by fitting it onto the top of the tank and that the Riser Tube from the Tank is fitted into the bottom hole of the Control Valve. Twist the Control Valve clockwise onto the top of the Fiberglass Mineral Tank until tightly secured with hand strength.

Important: DO NOT use Teflon tape or compound on these threads.



If you bought a 12" + tank, twist the Upper Basket onto the Control Valve before you fit the Control Valve onto the tank. Make sure the Riser Tube fits into the bottom of the Upper Basket.

Notes:

Don't use if you have heavy iron.

Must use for Fine Mesh Resin and Anion Resins.

Water Softener Tank Assembly and Valve Installation (continued)

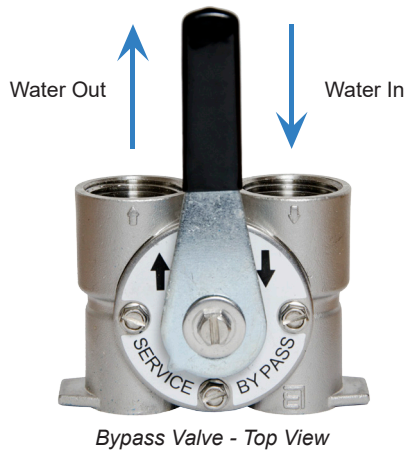

Next install the Bypass Valve into your existing water lines.

Make sure that your "Water In" always goes into the right-side of the Bypass as if you were looking at the Bypass from a top view.

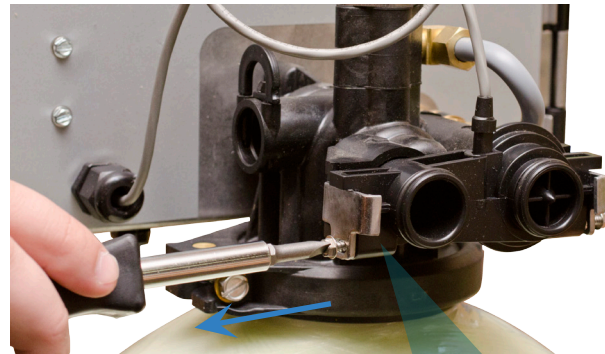

1.) Undo the clips from the back of the Control Valve before you move the Control Valve into place with the Stainless Steel Bypass that you just installed into your water lines.

Note: The clip has a alignment notch in the top. You will need to re-insert it first when tightening.

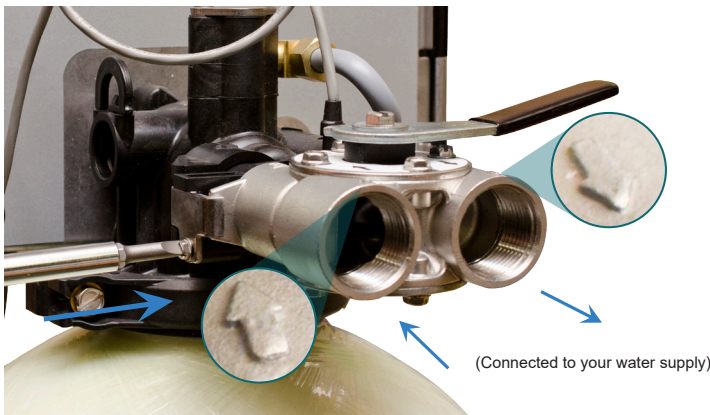

2.) Insert the Control Valve into place with the Bypass and then fasten with the clips. Make sure not to pinch the O-ring that are on the valve ports. Turn handle so it's pointing toward bypass.

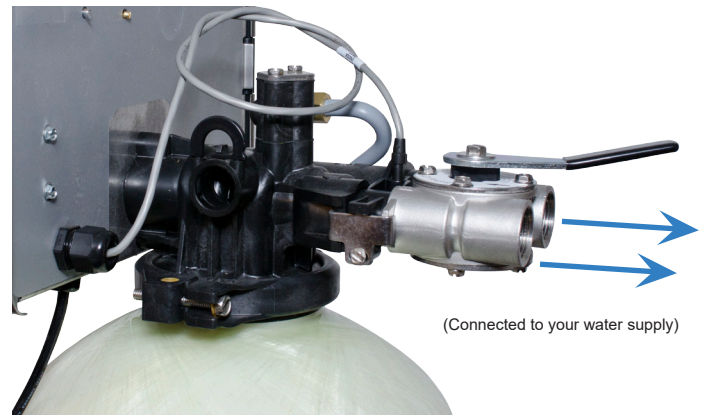

3.) Ensure that the measurements match the height of the valve ports in the back of the Control Valve.

Then plumb to valve.

Brine Tank Assembly

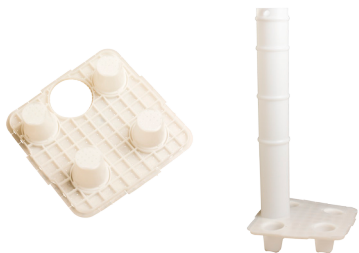

Snap the (4) Legs into the Salt Grid Base. Then insert the Float Tube into the Salt Grid Base. Push it through until it touches the ground.

Make sure that the hole in the Float Tube is facing straight outward (See next step).

Insert the Salt Grid Base you just assembled into the Brine Tank. Make sure that the hole in the Float Tube lines up with the hole in the Brine Tank.

NOTE: You will need to remove the Float Assembly to properly adjust

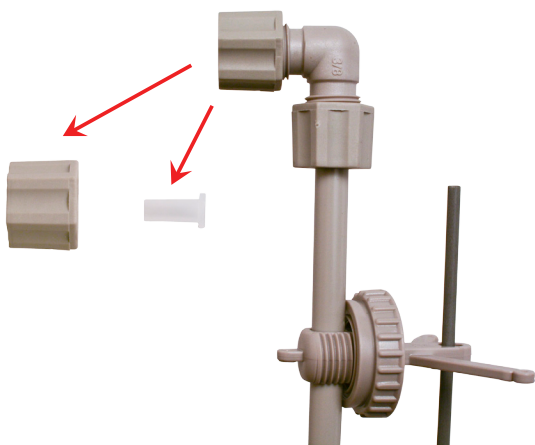

Remove the Nut from the top of the Float Assembly and set aside.

Watch for a small Plastic Insert that's hiding behind the Nut. You'll need to insert it into the Brine Hose. It's a good idea to do this right away so this small piece doesn't get lost.



Note: Make sure push that Plastic Insert all the way into the Brine Hose.

Adjust the rubber grommet on the Float Assembly to about 12 to 16 inches from the bottom of the Assembly.

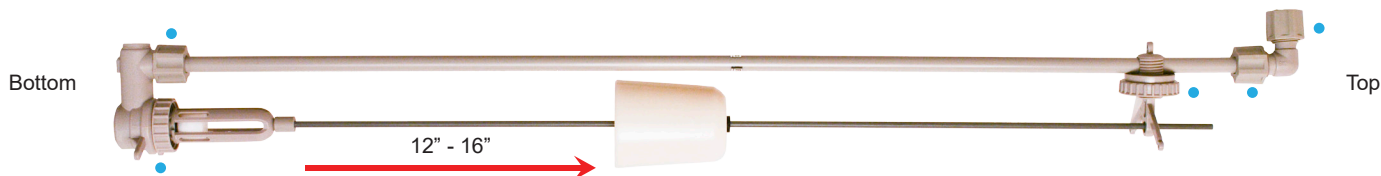

- Make sure all connections are **hand tight**. Be sure not to over tighten or use tools. It could damage the threads.

Brine Tank Assembly (continued)



Take the nut that you removed from the top of the float assembly and fit it onto the end of the brine hose. Fit enough so that just a little of the Brine Hose fits through the nut. It will be a snug fit so be sure it is tight.

Place the small plastic Insert into the end of the brine hose where you just fitted the nut.



Hand tighten the nut onto the elbow and place the float tube cap onto the float tube.

Next pour two, 40 lb bags of softening salt into your brine tank and place the cover of the brine tank on securely.

Important: Make sure not to over tighten the connections with tools. Doing so could damage the threads.

Assemble the Valve Connection Pieces into the other end of the Brine Hose.



Brine Tank Assembly (continued)

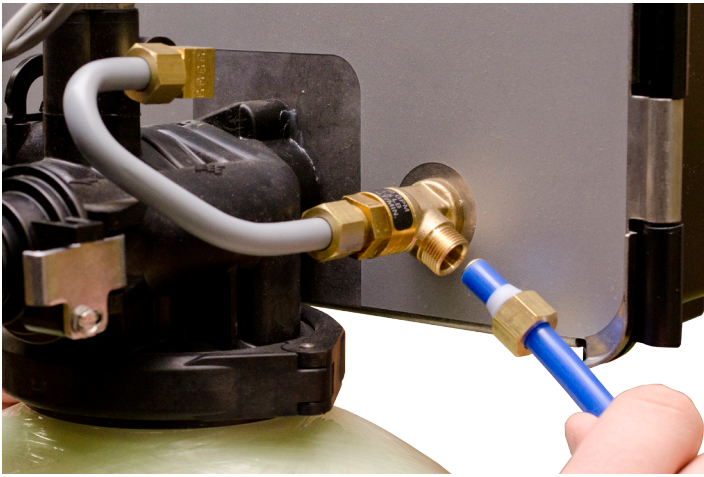

1.) Screw the valve connection assembly to the control valve.

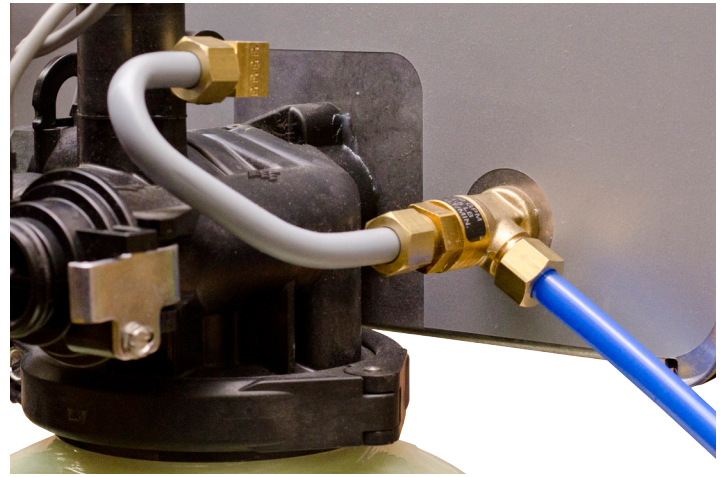

2.) Snug using an adjustable wrench.

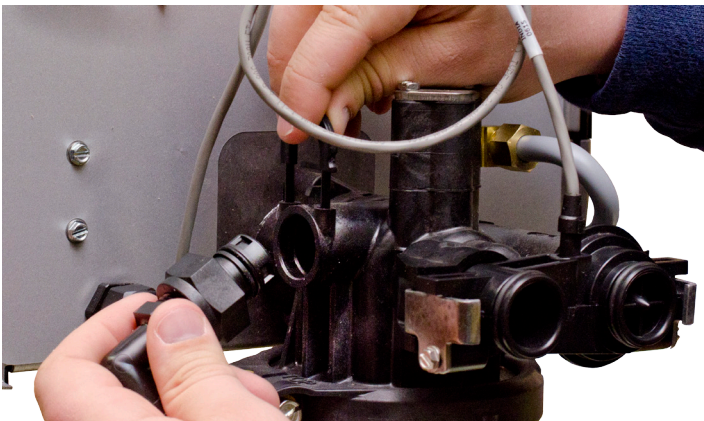

3.) Pull the clip out of the valve and slide the button coupling into the port. Then replace the clip.

Note: Typically comes pre-assembled by Aqua Science



Screw the two plastic fittings together. Be careful not to overtighten, it could damage threads.

Insert backflow reducer button into the assembly with the rounded inside edges facing out.

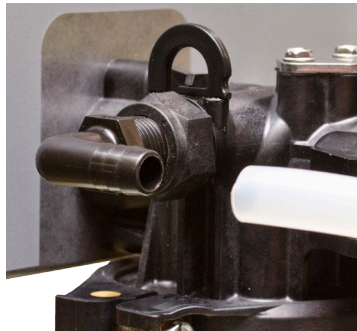
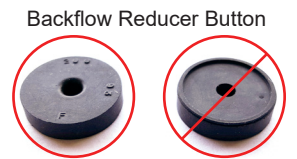

4.) Insert the backwash line onto the barb. It will be a snug fit. You will have to use a little force to get it all the way on.

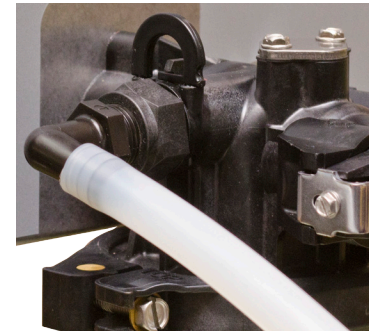

Fleck 2510 SXT Digital Programming

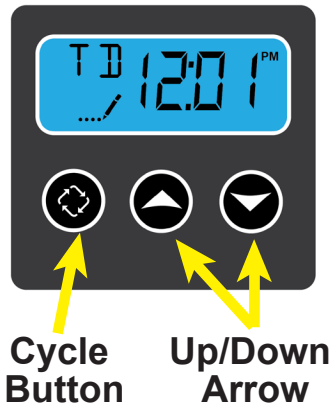

Step 1

To enter the programming mode you must first set the time to 12:01 PM. To do this use the up arrow or down arrow to change the time. You will see TD in the upper left corner when the time is being set.

After you set the time to 12:01 PM

- 1.) Press the cycle button once
- 2.) Press and hold the up and down arrow buttons at the same time until the screen changes to look like Step 2 below



Step 2

Press and hold the Up and Down Arrows at the same time for about 3 to 5 seconds until you see the setting DF (Display Format) GAL.

The value of GAL should show up as the default. If not, use the UP or DOWN Arrow to select GAL.

Press the Cycle button to advance to the next step.



Step 3

The next setting you'll see is VT (Valve Type). Set that to dF1b (Downflow 1 Backwash).

Press the Cycle button to advance to the next step.



Step 4

The next setting you'll see is CT (Control Type). Set that to Fd (Metered Flow Delayed).

Press the Cycle button to advance to the next step.



Step 5

The next setting you'll see is NT (Number of Tanks). Set that to 1.

Press the Cycle button to advance to the next step.

Fleck 2510 SXT Digital Programming (continued)



Step 6

The next setting you'll see is C (Capacity). Set to the capacity of your system. Refer to the chart at the bottom of the Parts List page to match tank size to proper filtration media amount.

Press the Cycle button to advance to the next step.



Step 7

The next setting you'll see is H (Hardness). Refer to your water test information for this value. Valves should be in GPG (grains per gallon). **Note: 1 GPG = 17.1 Mg/L**

Press the Cycle button to advance to the next step.



Step 8

The next setting you'll see is RS (Reserve Selection). Set the value to SF.

Press the Cycle button to advance to the next step.



Step 9

The next setting you'll see is SF (Safety Factor). The number value you see refers to percentage of reserve at which your system will regenerate. For example if you have a system that provides 1000 gallons of soft water and you set the Safety Factor to 15 (15%), after you've used 85%, your system will regenerate (RT - step 11) vs. using all 1000 gallons before it regenerates.

Press the Cycle button to advance to the next step.



Step 10

The next setting you'll see is DO (Day Override). Set this to 14.

Press the Cycle button to advance to the next step.

Fleck 2510 SXT Digital Programming (continued)



Step 11

The next setting you'll see is RT (Regen Time). By default this will be set to 2:00 AM. Customize this time according to your schedule where you won't be using any water or other system backwashing. It takes a couple hours for your system to regenerate.

Press the Cycle button to advance to the next step.



Step 12

The next setting you'll see is BW (Backwash). Set the value to 10.

Press the Cycle button to advance to the next step.



Step 13

The next setting you'll see is BD (Brine Draw). Set the value to 60.

Press the Cycle button to advance to the next step.



Step 14

The next setting you'll see is RR (Rapid Rinse). Set the value to 10.

Press the Cycle button to advance to the next step.



Step 15

The next setting you'll see is BF (Brine Fill). Set the value 12 minutes to 9x48, 15 minutes to 10x54, 19 minutes to 12x52.

Press the Cycle button to advance to the next step.



Step 16

The next setting you'll see is FM (Flow Meter). Set the value to t0.7.

Press the Cycle button to accept and you're all set with programming your Valve.

Fleck 2510 SXT Digital Programming (continued)

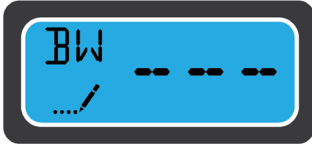

Step 17

While the tank is filling press and hold the cycle button until you see - - - -

This will allow the air to escape as the tank is filling. Once you see water coming out of the backwash line you can open the valve all the way and allow the system to go through a full cycle.

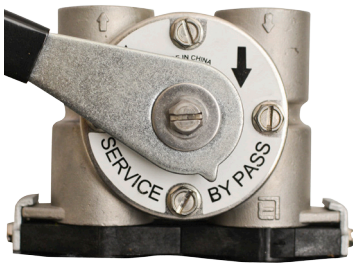

Step 18

Slowly turn the Bypass valve lever slightly to the letter "B" in the word Bypass. This will allow water to slowly fill your tank.

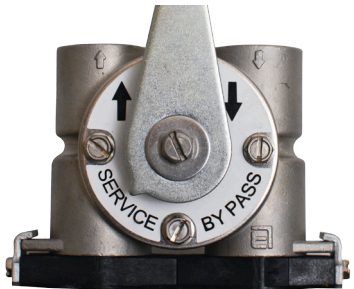

Step 19

Once the tank is full, turn the Valve lever fully to Service. You can check the status of the water fill by shining light through the tank.

If you need any help with your set up, please visit our easy to follow, resource rich website, www.aquascience.net or just give us a call at 800-767-8731.