

# Owner's Manual

# TROJAN MAX™

## Ultraviolet Water Purification System

Basic Models

A, B4, C4, D4, E4, F4

Plus Models

D4 Plus, E4 Plus, F4 Plus

**Congratulations.** By purchasing this system, you have taken the first step in ensuring safe drinking water. Designed using the most advanced UV technology available today, your UV system is designed to provide you with years of trouble free operation with minimal maintenance required.



### KEY INFORMATION YOU SHOULD KNOW:

- A 5-micron (nominal) sediment filter must be installed upstream of (before) any UV system
- This product is for **indoor use only**. Keep all components clean and dry.
- Clean the sleeve regularly for optimum performance

**Date of installation:** \_\_\_\_\_

**Installed by:** \_\_\_\_\_

**Installer phone#:** \_\_\_\_\_

**Serial #:** \_\_\_\_\_  
(Found on label on side of Power supply)

Trojan Technologies 3020 Gore Road, London, Ontario, Canada N5V 4T7  
www.trojanuv.com residential@trojanuv.com 1-800-265-5774

# SAFETY INSTRUCTIONS

## GROUNDING

This product must be grounded. If it should malfunction or breakdown, grounding provides a path of least resistance for electric current to reduce the risk of electrical shock. This system is equipped with a cord having an equipment-grounding conductor and a grounding plug. The plug must be plugged into an appropriate outlet that is properly installed and grounded in accordance with all local codes and ordinances.

**DANGER** – Improper connection of the equipment-grounding conductor can result in a risk of electrocution. Check with a qualified electrician or service personnel if you are in doubt as to whether the outlet is properly grounded. Do not modify the plug provided with this system – if it will not fit the outlet, have a proper outlet installed by a qualified electrician. Do not use any type of adapter with this system.

## GROUND FAULT CIRCUIT INTERRUPTER PROTECTION

To comply with the National Electrical Code (NFPA 70) and to provide additional protection from the risk of electric shock, this system should only be connected to a properly grounded, grounding-type power supply receptacle that is protected by a Ground Fault Circuit Interrupter (GFCI). Inspect operation of GFCI as per manufacturers suggested maintenance schedule.

## EXTENSION CORDS

If an extension cord is necessary, use only 3-wire extension cords that have 3-prong grounding-type plugs and 3-pole cord connectors that accept the plug from this system. Use only extension cords that are intended for outdoor use. Use only extension cords having an electrical rating not less than the rating of the system. A cord rated for less amperes or watts than this system rating may overheat. Exercise caution when arranging the cord so that it will not be tripped over or pulled. Do not use damaged extension cords. Examine extension cord before using and replace if damaged. Do not abuse extension cord. Keep extension cord away from heat and sharp edges. Always disconnect the extension cord from the receptacle before disconnecting this system from the extension cord. Never yank cord to pull plug from outlet. Always grasp the plug and pull to disconnect.

## WARNING –

To guard against injury, basic safety precautions should be observed, including the following:

1. READ AND FOLLOW ALL SAFETY INSTRUCTIONS.
2. **DANGER** – To avoid possible electric shock, special care should be taken since water is employed in the use of this system. Unless a situation is encountered that is explicitly addressed by the provided maintenance and troubleshooting sections, do not attempt repairs yourself; refer to an authorized service facility.
3. **CAUTION** - Do not operate with broken or faulty parts as this may result in exposure to ultraviolet radiation. Contact supplier for replacement parts.
4. Do not operate the system if it has a damaged cord or plug, or if it is malfunctioning or if it has been dropped or damaged in any manner.
5. Always unplug the system, shut off water flow and release water pressure before servicing or cleaning. Never yank cord to remove from outlet; grasp the wall plug and pull to disconnect.
6. Do not use the system for other than intended use. The use of attachments not recommended or sold by the manufacturer may cause an unsafe condition.
7. To prevent risk of electrical shock, connect this system only to a properly grounded, grounding-type power supply receptacle that is protected by a Ground Fault Circuit Interrupter (GFCI). Inspect performance of GFCI as per manufacturer's suggested maintenance schedule. If an extension cord is used, ensure it is of a sufficient rating and accepts the plug from this system; never use an adapter.
8. Visually inspect this system prior to installation. If the quartz sleeve or lamp is broken, cracked or damaged in any way, do not use. Contact the supplier for replacement parts.
9. Keep all connections dry and off the ground. Do not touch plug with wet hands.
10. The light emitted by the lamp will cause serious eye damage and burn unprotected skin. Do not plug system into an electrical outlet without first properly securing the lamp into the chamber. Unplug the system prior to removing the lamp from the chamber.
11. If the UV system malfunctions or fails, water must be boiled prior to consumption until the UV system is operational and the water lines have been shocked. System failure is indicated by the system's audible and visual alarms or the absence of any indicator light.
12. Intended for indoor use only. System must not be exposed to weather elements. In seasonal applications, chamber must be drained to prevent freezing.
13. Installation of this system must be in accordance with local plumbing and electrical codes as well as any and all applicable regulations and laws.
14. SAVE THESE INSTRUCTIONS.



**WARNING** – To prevent risk of electrical shock, connect this system only to a properly grounded, grounding-type power supply receptacle that is protected by a Ground Fault Circuit Interrupter. Pull plug before servicing or replacing lamp. Keep all connections dry and off the ground. Do not touch plug with wet hands.



**WARNING** – Do not look directly at UV lamp when it is operating. The light emitted by the lamp will cause serious eye damage and burn unprotected skin.



**WARNING** – Read manual before installing or servicing this system. Only authorized personnel possessing a strong understanding of this system should attempt to replace lamp or service this system.

**NOTE** – Maximum pressure rating is 125 PSI (8.62 bar)

# TABLE OF CONTENTS

<b>Overview</b>	<b>4</b>
What model do I have?	4
Specifications	5
Components	6
Dimensions and layout	8
<b>Installation</b>	<b>10</b>
Installing the UV system	10
Disinfecting the water lines	12
<b>Operation</b>	<b>15</b>
Control panel (not applicable to Model A)	15
Troubleshooting	16
Low UV alarms (Plus models only)	17
<b>Maintenance</b>	<b>18</b>
Sleeve cleaning and lamp replacement	18
<b>Warranty</b>	<b>22</b>

# WHAT MODEL DO I HAVE?

To find out what model you have, look at the label on the side of the power supply.

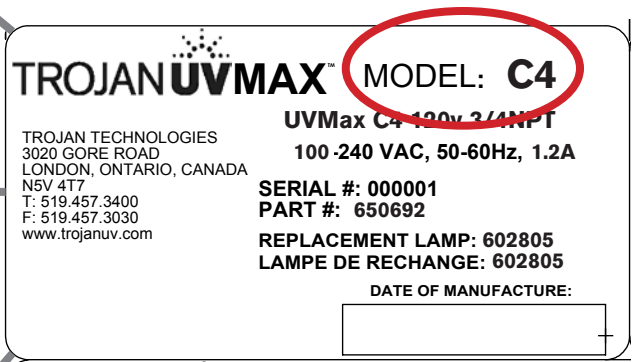



Example label of model C4

	A	B4	C4	D4/D4 Plus	E4/E4 Plus	F4/F4 Plus
No-tools maintenance	Yes	Yes	Yes	Yes	Yes	Yes
Safety cap & special lamp plug	Safety cap only	Yes	Yes	Yes	Yes	Yes
Lamp operation indicator	Yes	Yes	Yes	Yes	Yes	Yes
Power supply operation indicator	Yes	Yes	Yes	Yes	Yes	Yes
Sensor operation indicator	--	--	--	D4 Plus	E4 Plus	F4 Plus
Sensor with diagnostic test	--	--	--	D4 Plus	E4 Plus	F4 Plus
Reference card	--	Yes	Yes	Yes	Yes	Yes
Lamp timer display	--	--	--	Yes	Yes	Yes
Lamp timer reset button	--	--	--	Yes	Yes	Yes
Mute button	--	--	--	Yes	Yes	Yes
Solenoid valve	--	--	--	Optional	Optional	Optional
External control relay	--	--	--	Optional	Optional	Optional

# SPECIFICATIONS

## General (All Models)

Operating Parameters	
Maximum operating pressure	125 PSI (862 kPa)
Minimum operating pressure	4 PSI (27.5 kPa)
Maximum ambient air temperature	122 °F (50°C)
Minimum ambient air temperature	32°F (0°C)
Maximum humidity	100%
Maximum hardness	120 ppm (7 grains per gallon)
Maximum iron	0.3 ppm
Minimum UVT	75%
Installation	Vertical or horizontal*
<b>Other</b>	
Rated service life of lamp	1 year
Certification	  

\*Systems with sensors must be installed vertically.

\*\*Model A is only system certified by CSA and not by UL.

	A	B4	C4	D4/D4 Plus	E4/E4 Plus	F4/F4 Plus
<b>Flow Rates</b>						
Maximum rated flow at dose of 16 mJ/cm <sup>2</sup>	3 GPM (11 LPM)	6 GPM (23 LPM)	16 GPM (60 LPM)	16 GPM (60 LPM)	29 GPM (110 LPM)	45 GPM (170 LPM)
Maximum rated flow at dose of 30 mJ/cm <sup>2</sup>	1 GPM (4 LPM)	4 GPM (15 LPM)	9 GPM (34 LPM)	9 GPM (34 LPM)	15 GPM (57 LPM)	25 GPM (95 LPM)
Maximum rated flow at dose of 40 mJ/cm <sup>2</sup>	1 GPM (4 LPM)	3 GPM (11 LPM)	7 GPM (26 LPM)	7 GPM (26 LPM)	12 GPM (45 LPM)	20 GPM (76 LPM)
<b>Electrical</b>						
Voltage	120V or 230V AC	100-240V AC	100-240V AC	100-240V AC	100-240V AC	100-240V AC
Frequency	50-60 Hz	50-60 Hz	50-60 Hz	50-60 Hz	50-60 Hz	50-60 Hz
Max. current	0.4 Amp	0.4 Amp	0.5 Amp	0.5 Amp	0.85 Amp	1.2 Amp
Max. power consumption	22 Watts	36 Watts	50 Watts	50 Watts	83 Watts	130 Watts
Lamp power	14 Watts	25 Watts	40 Watts	40 Watts	70 Watts	110 Watts
<b>Other</b>						
UV Chamber Material	304 SST	304 SST	304 SST	304 SST	316 SST	316 SST
Inlet/Outlet	3/8" FNPT	3/4" NPT	3/4" NPT	3/4" NPT	1" NPT	1" NPT

Flow rates shown are at 85% UVT.

## COMPONENTS

For replacement components please contact your installer (listed on the front of this manual) or contact Trojan directly for a referral: 1-800-265-5774 (North America), 519-457-3400, or residential@trojanuv.com.



### Components - Model A

Part	Part Number
1 Power supply (includes Safety cap, Lamp cord)	650414
2 Safety cap	--
3 Lamp cord	--

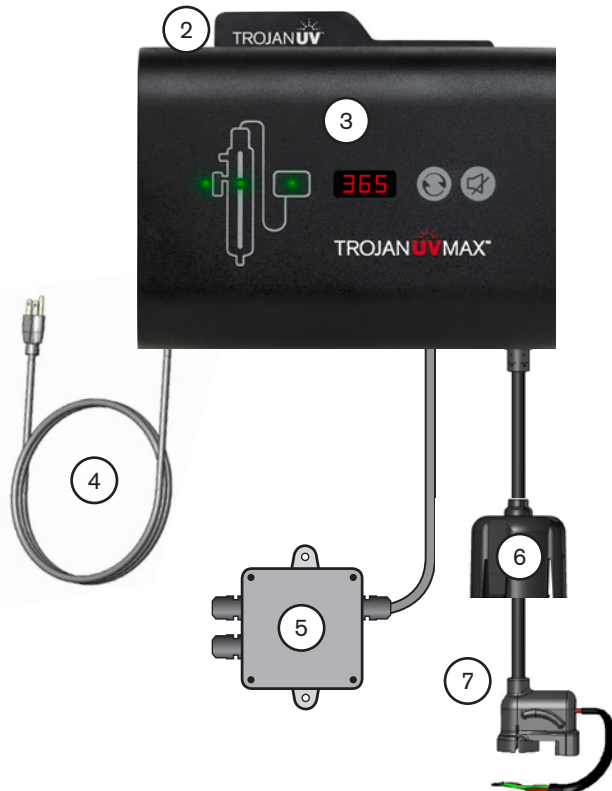
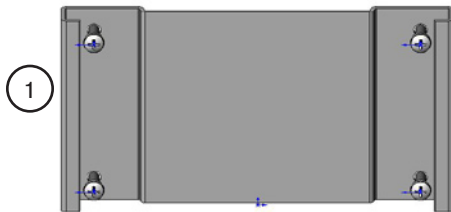

### Components - B4, C4, D4, E4, F4 and Plus models

Part	Model	Part Number
1 Power supply mounting bracket	All	--
2 Reference card	All	--
3 Power supply (includes Power supply mounting bracket, Reference card, Safety cap, Lamp cord)	B4	650713-005
	C4	650713-006
	D4	650713-007
	D4 Plus	650713-008
	E4	650713-001
	E4 Plus	650713-002
	F4	650713-003
	F4 Plus	650713-004
4 Power cord	All	602636
5 Junction box (optional)	D4, D4 Plus, E4, E4 Plus, F4, F4 Plus	650705
6 Safety cap	All	603000
7 Lamp cord	All	--

### Components - All Models



Part	Model	Part Number
7 Lamp (includes O-rings)	A	602803
	B4	602804
	C4, D4, D4 Plus	602805
	E4	602806
	F4	602807
8 O-ring	All	--
9 Sleeve bolt	All	602665
10 Sleeve (includes O-rings)	A	602730
	B4	602731
	C4, D4, D4 Plus	602732
	E4	602733
	F4	602734
11 UV Chamber (includes Chamber clamp(s), and Ring clamp*).	All	--
12 Ring clamp*	All, except Model A	--
13 Chamber clamp(s)	All	--
14 Solenoid valve kit (optional) (includes Junction Box)	D4, D4 Plus (3/4")	650717-001
	E4, E4 Plus, F4, F4 Plus (1")	650717-002
15 CoolTouch valve	D4 Plus (3/4")	650537
	E4 Plus, F4 Plus (1")	650538
	Plus Models	650703
16 Sensor	Plus Models	650703

\*Item not included on Model A.

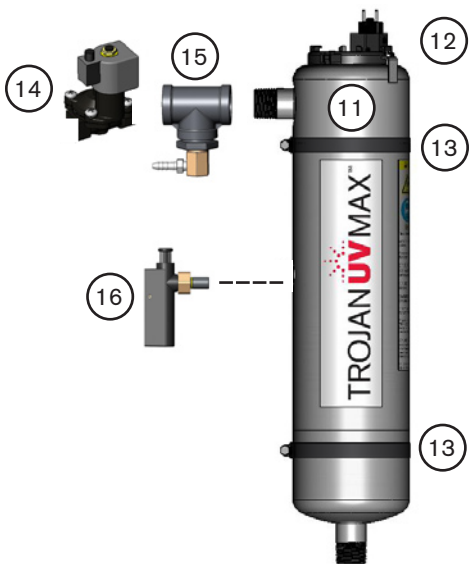

# DIMENSIONS AND LAYOUT

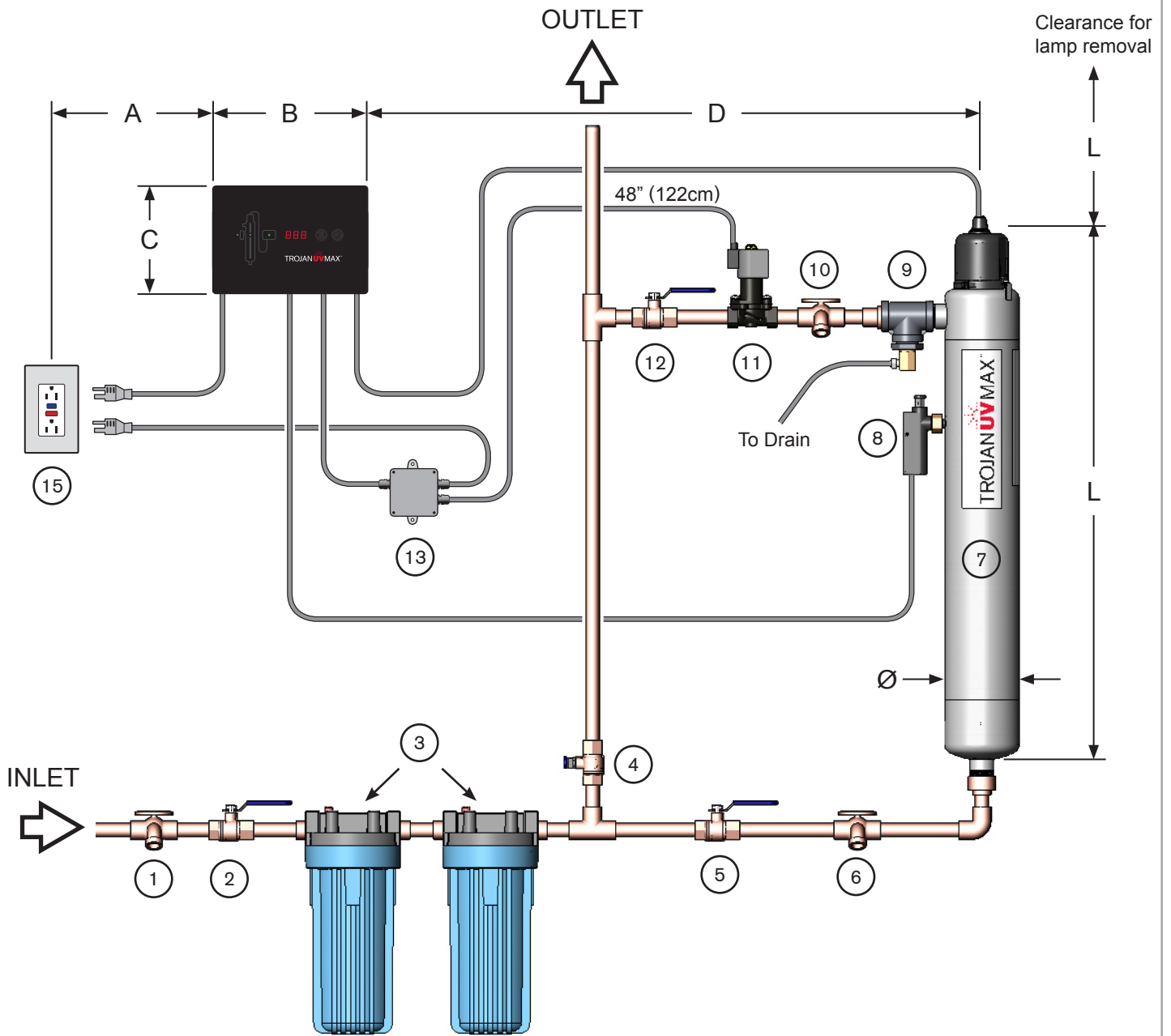

Model	L	Ø	A (max.)	B	C	D (max.)
A	15.5" (39cm)	2.5" (6.5cm)	N/A	2.8" (7cm)	3.3" (8cm)	48" (122cm)
B4	14.5" (37cm)	4" (10cm)	72" (183cm)	8.5" (22cm)	6" (15cm)	54" (137cm)
C4	20.5" (52cm)	4" (10cm)	72" (183cm)	8.5" (22cm)	6" (15cm)	54" (137cm)
D4, D4 Plus	20.5" (52 cm)	4" (10cm)	72" (183cm)	8.5" (22cm)	6" (15cm)	54" (137cm)
E4, E4 Plus	30" (76cm)	4" (10cm)	72" (183cm)	8.5" (22cm)	6" (15cm)	54" (137cm)
F4, F4 Plus	44.25" (112.4cm)	4" (10cm)	72" (183cm)	8.5" (22cm)	6" (15cm)	54" (137cm)



- 1 **Sample valve:** Allows for sampling of raw water.
- 2 **Shut-off valve:** Required to allow maintenance of pre-treatment equipment.
- 3 **Pre-treatment (illustrative only):** For the UV system to operate effectively, the water should meet certain water quality parameters, as outlined below. To meet these, pre-treatment of the water may be required. Pre-treatment equipment must be installed BEFORE the UV chamber. Pre-treatment systems can be comprised of one or more of the following elements: sediment filters; carbon filters; iron removal systems; water softeners; cyst reduction filters, etc.

**Water Quality Requirements:**

Iron:	< .3 PPM (.3 mg/L)
Hardness:	< 120 PPM (7 Grains Per Gallon)
% UVT:	> 75%

**IMPORTANT:**  
**A 5 micron (nominal) sediment filter must be installed before the UV system and after any water softening equipment**

- 4 **Bypass shut-off valve:** Bypass line and valve are optional. Intended to provide emergency water supply in the event that the UV system is unavailable.
- 5 **Shut-off valve:** Required to allow maintenance of UV system.
- 6 **Sample valve:** Allows for sampling of water entering UV chamber; necessary in order to confirm water being treated is of adequate quality.
- 7 **UV chamber:** Provides disinfection of the water. Must install Plus model chambers vertically.
- 8 **Sensor:** Optional item included with Plus models. Monitors UV output to ensure proper dose (UV exposure) is being provided. Unique test function allows verification of sensor operation.
- 9 **CoolTouch™ valve:** Drains water from the chamber that's been warmed by the lamp during periods of no flow.
- 10 **Sample valve:** Allows for sampling of water immediately following UV treatment; necessary in order to confirm proper operation of UV system.
- 11 **Solenoid valve:** Optional piece of equipment supplied by Trojan for D4, E4, F4 and Plus models. Must be used with a junction box. Allows water supply to be shut-off when proper purification cannot be assured.

Note: If the ground from your electrical panel is tied to your copper water lines, and you are using a solenoid valve, installation of an approved ground strap is required. This ground strap will maintain continuity between the lines that have been cut to install the solenoid. Check your local electrical code for the correct clamp and cable size.

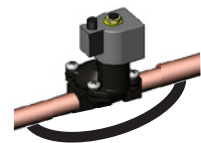

- 12 **Shut-off valve:** Required to allow maintenance of UV system.
- 13 **Junction box:** An optional piece of equipment for D4, E4, F4 and Plus models. Powers solenoid valves, remote alarms and auto-dialers.
- 14 **Power supply:** Powers and controls the UV lamp and other devices. Provides human interface, displaying information and allowing control inputs (such as muting the audible alarm).
- 15 **Power source:** Provides power to the power supply. For safety reasons the outlet must be protected by a Ground Fault Circuit Interrupter (GFCI). NOTE: to protect the power supply, a UL1449 certified (or equivalent) transient voltage surge suppressor is required.

## INSTALLING THE UV SYSTEM

- 1 Determine appropriate **indoor** location of the power supply and chamber, referring to **Dimensions and Layout** drawing. Power supply should be installed higher than chamber away from all water sources. Ensure adequate clearance above chamber to allow for removal of the lamp and sleeve.

- 2 Screw chamber clamp(s) to the wall (#10 screws recommended.)

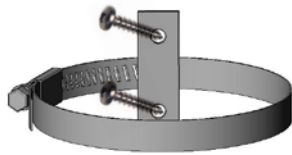

- 3 Insert chamber and tighten clamp(s).



- 4 Make all necessary plumbing connections referring to **Dimensions and Layout** drawing.

**Model A:** Skip to step 9.  
Safety cap, lamp plug and power supply figures will look slightly different than those on your system.

- 5 Install power supply mounting bracket to wall using four #8 screws (not provided).



- 6 Slide power supply onto mounting bracket.

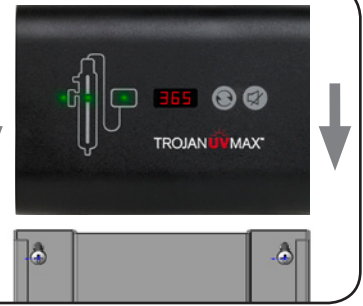

- 7 Slide Reference card behind power supply.



- 8

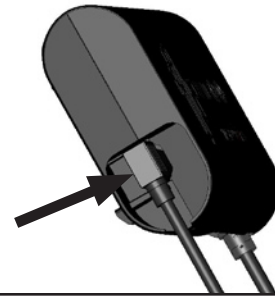

- 9 Insert Lamp/sleeve assembly and screw into chamber.

Caution: Over tightening will break the sleeve.

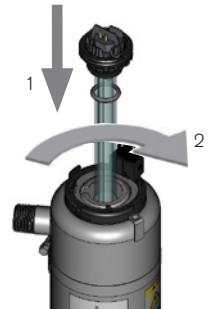

- 10 Align connections by rotating ring clamp (if equipped) to push lamp plug onto end of lamp.

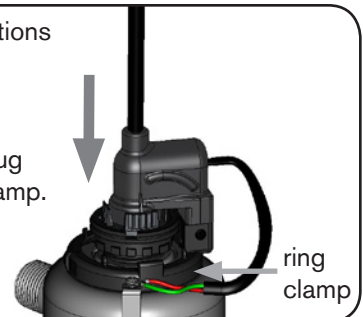

- 11 Attach ground (green/yellow) and strain relief (red) wires from the lamp plug to the ground lug on the chamber. Secure both wires with locking screw provided.

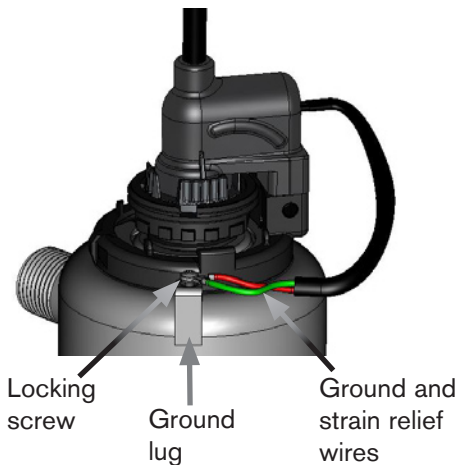

- 12 Push safety cap into place.

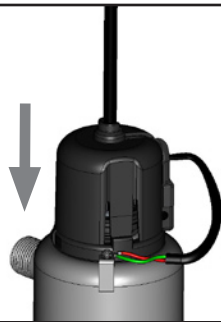

- 13 For Plus models only.



- 14 Plug sensor into blue jack (Plus models only).

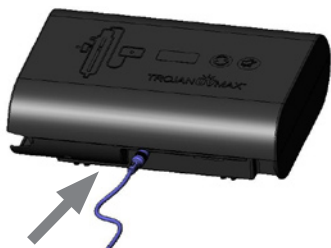

- 15 Outlet must be protected by a Ground Fault Circuit Interrupter (GFCI).



- 16 Let water flow to one faucet or other water outlet, then close the outlet and check for leaks.

Proceed to **Disinfecting The Water Lines**.

## DISINFECTING THE WATER LINES

UV systems disinfect the water using ultraviolet light, treating the water as it passes through the system. When there is a risk that water downstream of the UV system has been contaminated, it is critical that these water lines be chemically disinfected. Disinfection of the water lines is therefore required after initial system installation and following any period of time during which the system is inoperative, whether due to an alarm condition, a power failure, or for any other reason. Make sure the UV system is on during the entire disinfecting process.

1

**Plus models only:**  
Unplug power supply and then unplug sensor from blue jack.

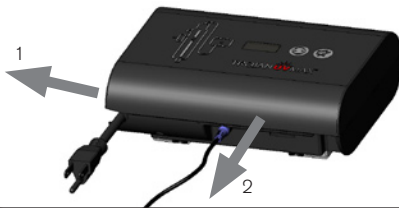

2

Make sure power supply is plugged in for entire disinfection process.

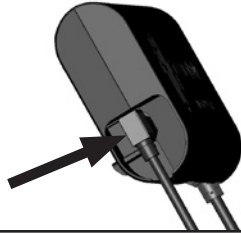

3

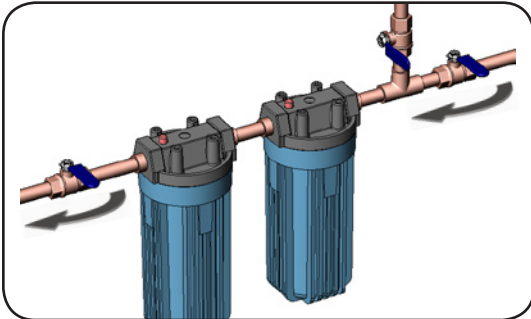

4

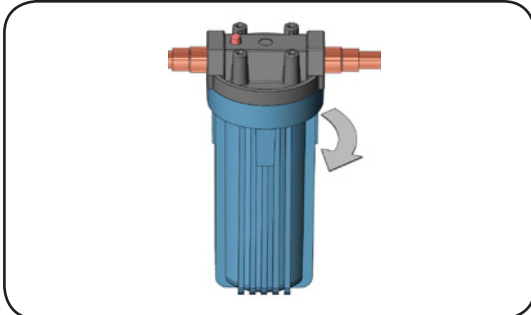

5

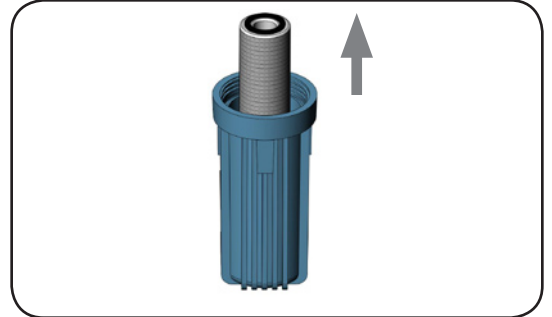

6



7

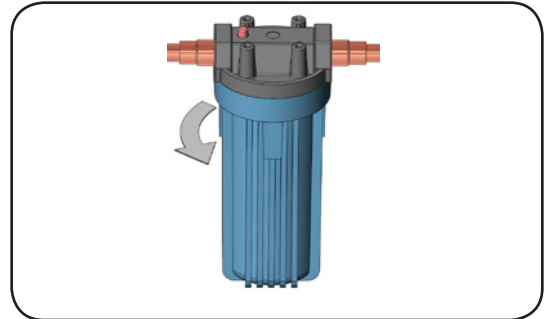

8

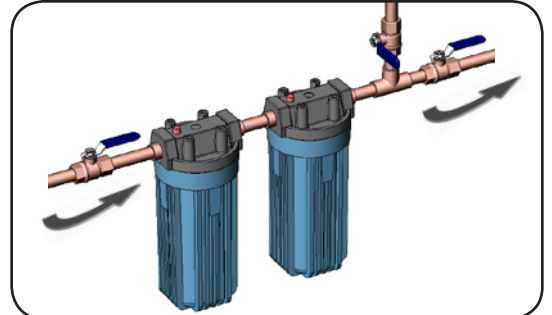

9 Allow water to fill UV chamber.

10

11 Go to a water outlet and allow the cold water to flow until you can smell bleach, then stop the flow. Allow hot water (if present) to flow until you can smell bleach, then stop the flow. Repeat procedure at all water outlets. Remember to include all faucets, washing machines, toilets, outside taps, and other water outlets. **Note:** You will likely run out of bleach; if you cannot smell bleach at a given outlet, turn off the main water supply, depressurize and add more bleach to the filter housing.



12 Let the bleach sit in the water lines for at least four hours.

13

14

15

16

17

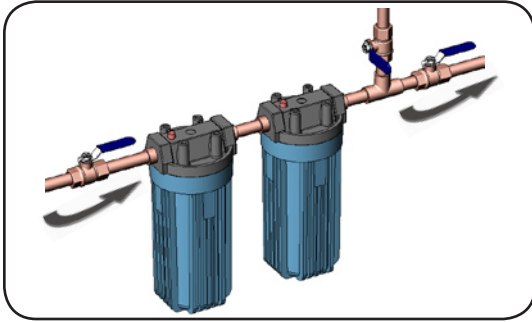

18

Flush all water outlets until bleach can no longer be smelled (at least 5 minutes).



19

Remainder of steps for Plus models only.

20

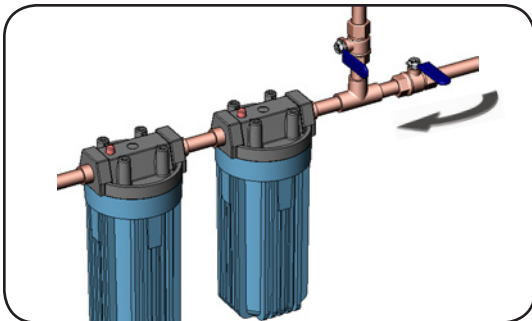

21



22

Plug sensor into blue jack.

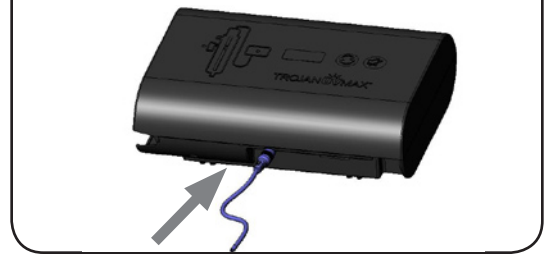

23



24

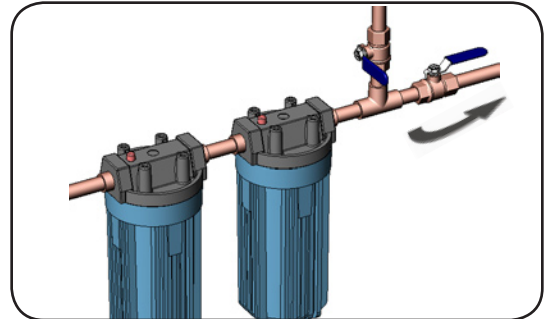



## CONTROL PANEL (not applicable to Model A)

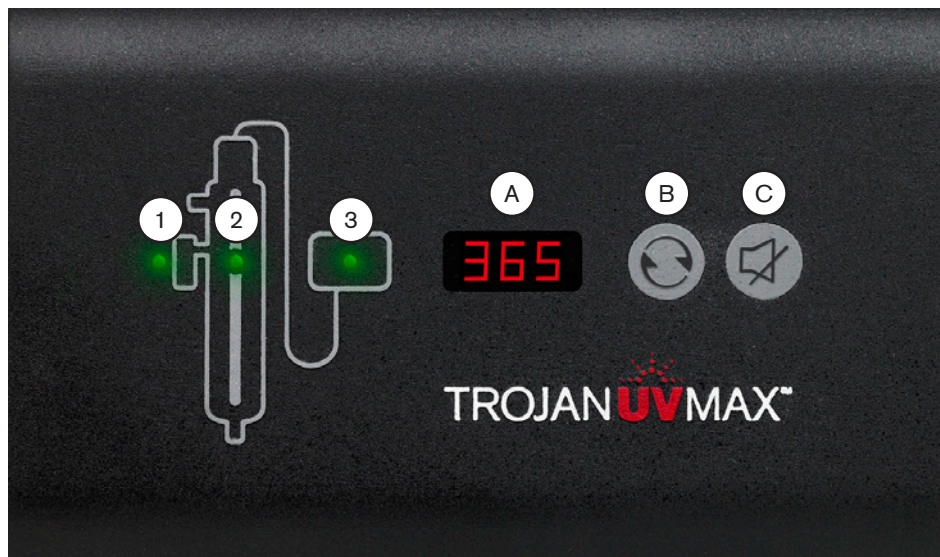

### Buttons and Display

For D4, E4, F4 and Plus models only.

(A)	Lamp timer display	Counts <i>down</i> from 365 days to show time for annual lamp replacement.
(B)	Lamp timer reset	After installing a new lamp, press and hold for five seconds to reset Lamp timer to 365.
(C)	Mute	Press to silence audible alarm.  When the alarm is due to the lamp's age, the mute button will silence the audible alarm for 7 days; this may be repeated up to a maximum of 4 times. After that, the button will silence for only 24 hours.  When the alarm is due to any other issue, the mute button will silence the audible alarm for 24 hours.

### Indicator lights

Indicator lights only indicate a problem with the component when flashing red.

The table below is a list of *possible* causes and solutions. Before replacing parts, please contact Trojan Technical Assistance for any new troubleshooting techniques. 1-800-265-5774

	Green	Yellow*	Flashing red	Solid red
(1) (Plus models only)	UV dose is adequate and sensor is operating normally	UV dose is near the minimum required	Sensor disconnected; unplug system, reconnect sensor and plug-in system again  UV dose is below minimum required, see <b>Low UV Alarm</b> section	Sensor inactive due to lamp or power supply failure
(2)	Lamp operating normally	Warning; lamp will require replacement shortly	Lamp disconnected; unplug system, reconnect lamp and plug-in system again  Lamp failure; replace lamp	Lamp inactive due to power supply failure
(3)	Power supply operating normally	Air temperature around system is too warm	Power supply failure; replace power supply	Power supply inactive due to lamp failure

\* Yellow indicator lights are a function of D4, E4, F4 and Plus models only.

## TROUBLESHOOTING

The table below is a list of *possible* causes and solutions. Before replacing parts, please contact Trojan Technical Assistance for any new troubleshooting techniques. 1-800-265-5774

Symptom	Possible cause	Possible solution
No power	GFCI and/or breaker tripped	Reset GFCI and/or breaker
	Transient voltage surge suppressor (TVSS) damaged	Replace TVSS
	Power supply damaged	Replace power supply and use a TVSS
GFCI or breaker repeatedly trips	Connection between lamp and lamp plug is wet	Clean and dry lamp pins and lamp plug, check unit for leaks or condensation
	Short-circuit in the electrical assembly	Replace power supply
Leak at inlet or outlet	Threaded pipe fittings are leaking	Clean threads, reseal with Teflon tape and retighten
Leak detected from area of UV chamber	Condensation of moist air on cold chamber (slow accumulation)	Control humidity or relocate unit
	O-ring damaged, deteriorated or incorrectly installed	Inspect and replace if deteriorated
	Lamp/sleeve assembly not properly installed (too tight or not tight enough)	Tighten assembly hand-tight
Leak detected at sensor (if so equipped)	UV sensor o-rings are damaged, deteriorated, or incorrectly installed	Inspect and replace o-rings if deteriorated
Alarm	See <b>Control Panel</b> section	See <b>Control Panel</b> section
System is operating but water tests reveal bacterial contamination	Equipment downstream of UV system is acting as a breeding ground for pathogens	Ensure UV is the last piece of treatment equipment
	Pathogens are residing in the distribution lines post-UV	Ensure all distribution lines have been disinfected with chlorine - see <b>Disinfecting the Water Lines</b> section
	Recontamination from pipe dead-ends	Remove any pipe dead-ends and flush with chlorine - see <b>Disinfecting the Water Lines</b> section
Lamp timer does not read anything	Unit is unplugged	Plug unit into AC power outlet
	No power at AC power outlet	Replace fuse or reset breaker
	Power cord is damaged	Replace power cord
	Power surge caused damage to electrical assembly	Replace power supply and use a surge protector



## LOW UV ALARMS (PLUS MODELS ONLY)

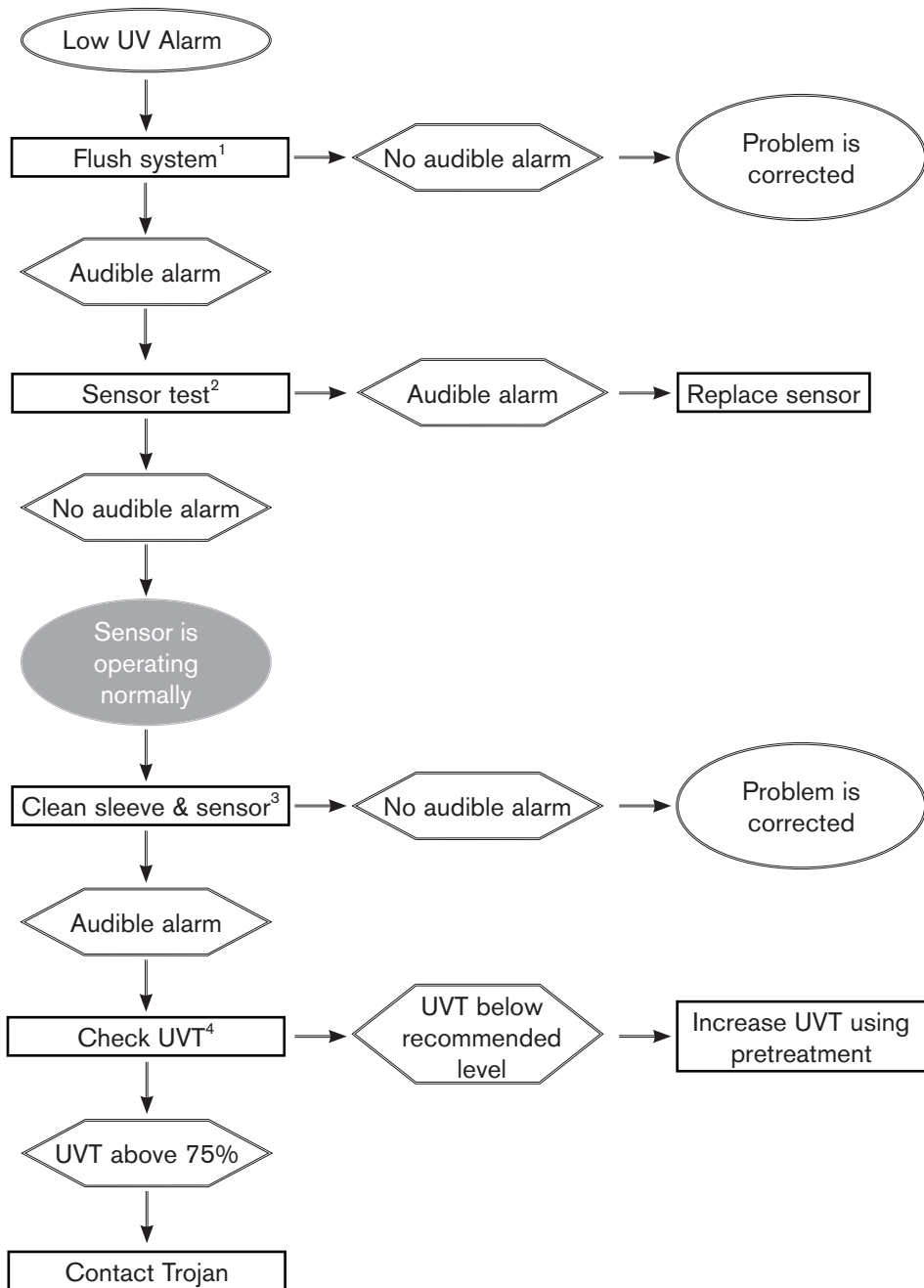

- 1 In some cases, short-term flows of low ultraviolet transmittance (UVT) water can be created following and during the regeneration cycle of a water softener, resulting in a sensor alarm. Flushing the UV system alleviates this condition until the softener goes through another regeneration cycle. In the longer term, the softener's settings must be modified. To flush the UV system, disinfect the water lines following the procedures outlined under "**Disinfecting The Water Lines**" in the Installation section.
- 2 Plus models are equipped with a unique, patented, self-test sensor. Simply press the test button located at the top of the sensor and hold until the audible alarm stops (usually about 5 seconds). If the audible alarm is still present after 30 seconds, release the button and replace the sensor.
- 3 Refer to **Sleeve Cleaning And Lamp Replacement** section of the Owner's Manual.
- 4 Contact Trojan or your water treatment dealer for a test of the UVT of the water.

## SLEEVE CLEANING & LAMP REPLACEMENT

### Sleeve cleaning

Minerals in the water slowly form a coating on the sleeve. This coating must be removed because it reduces the amount of UV light reaching the water, thereby reducing purification performance.

*Basic models:* please clean the sleeve regulary (3-4 times per year, or more often depending on water quality).

*Plus models:* the need to clean the sleeve will be indicated by a low UV alarm (flashing red indicator light beside the sensor on control panel - see **Control Panel** section for details).

When only cleaning is required, follow instructions and re-install the current lamp.

### Lamp replacement

The amount of UV light created by the lamp decreases over time, requiring that the lamp be replaced every **12 months**. NOTE: The UV system is designed to operate continuously and should not be shut off for short periods of time, such as over a period of less than three weeks.

*A, B4, C4 Models:* Please keep track of your lamp's life. After 12 months follow these instructions to replace system with a new lamp.

*D4, E4, F4 and Plus Models :* The system will automatically notify you after 12 months to replace the lamp. Follow these instructions.

### Equipment required:



Clean cotton, latex or plastic gloves are preferred.



Scale remover such as CLR™ or Lime-A-Way™.



Cloth must be soft, lint-free, and chemical-free. No clean-wipes.



Cotton swab.  
(For Plus models only)

Model A: Safety cap, lamp plug and power supply figures will look slightly different than those on your system.

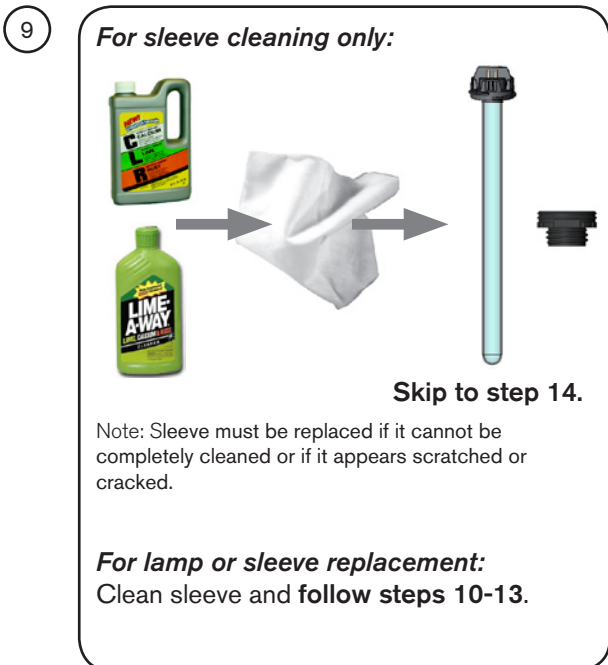
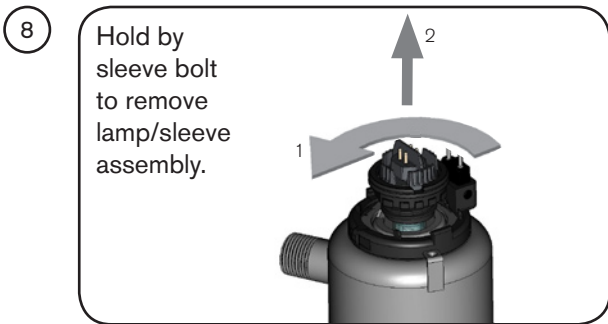
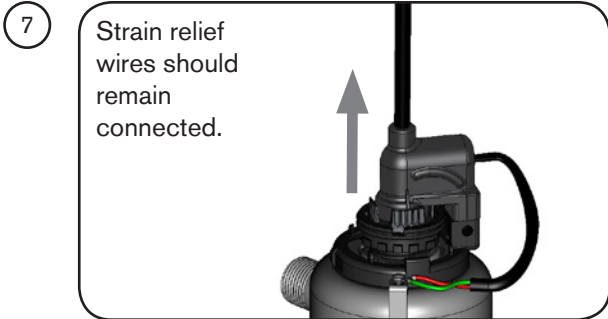
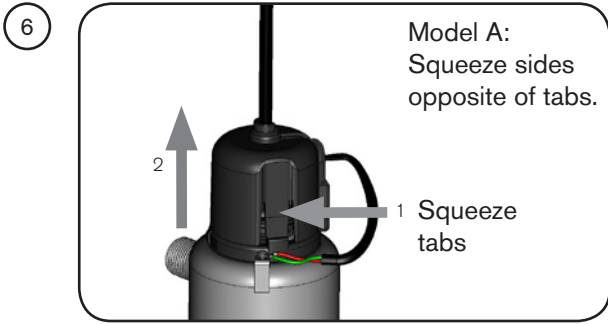
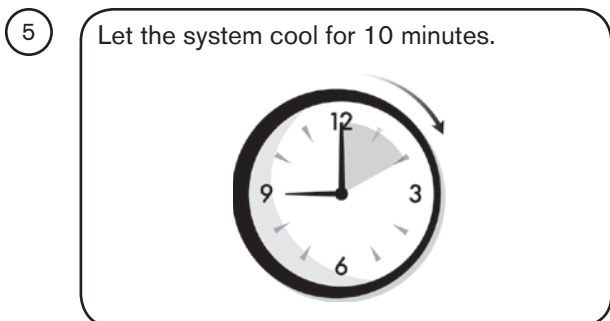
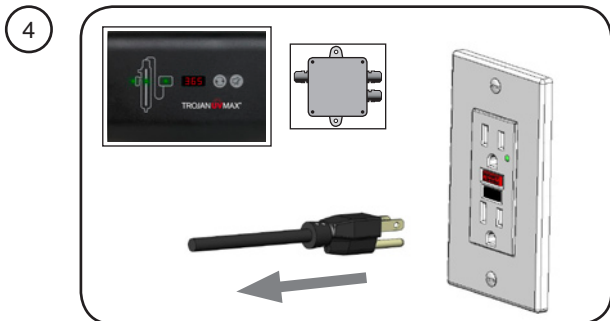
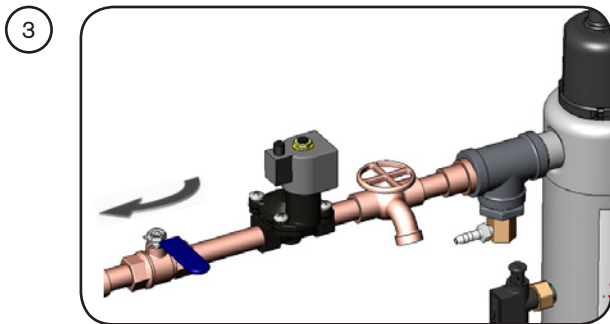
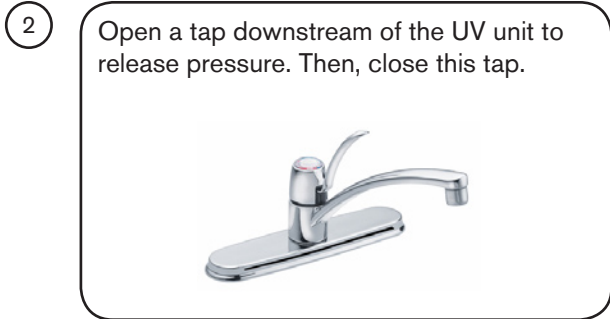
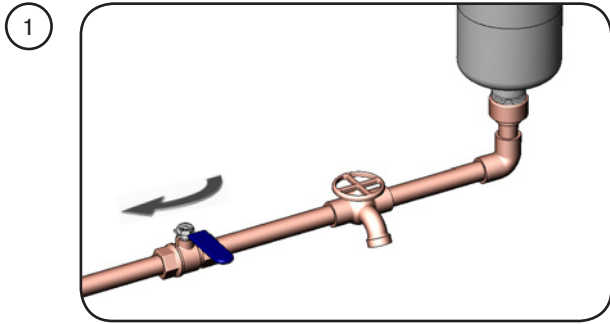

- 10 Hold sleeve bolt with one hand. Use other hand to unscrew lamp from sleeve by holding lamp tab.

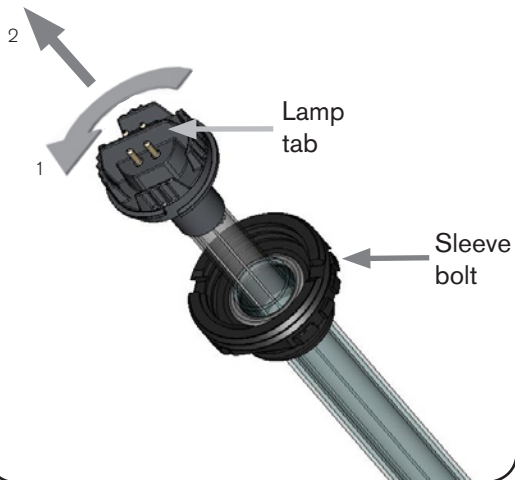

- 11 Remove o-rings and sleeve bolt from sleeve.

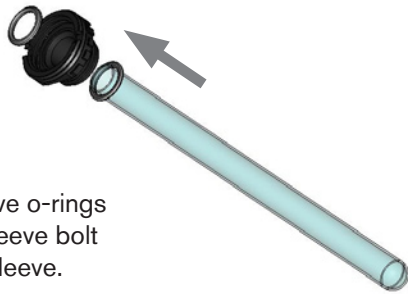

- 12 Reinstall sleeve bolt with 2 new o-rings.

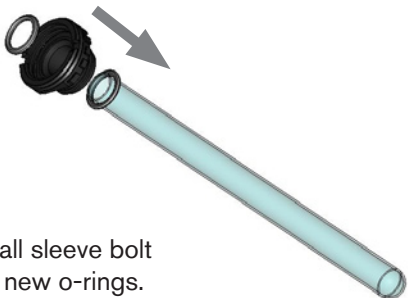

- 13 Screw lamp into sleeve hand-tight.
- Caution: Over tightening will break the sleeve.



- 14 Make sure lamp/sleeve assembly is centered.
- Caution: Over tightening will break the sleeve.
- For Basic models, **skip to step 18.**

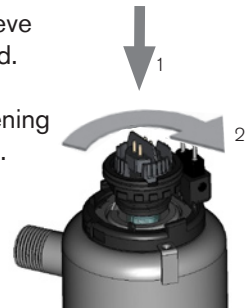

- 15

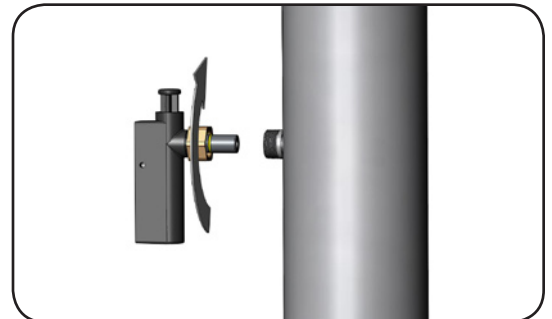

- 16

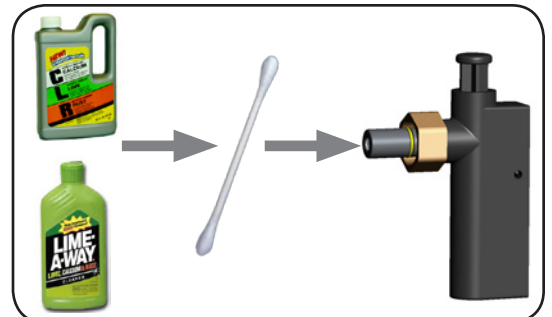

17

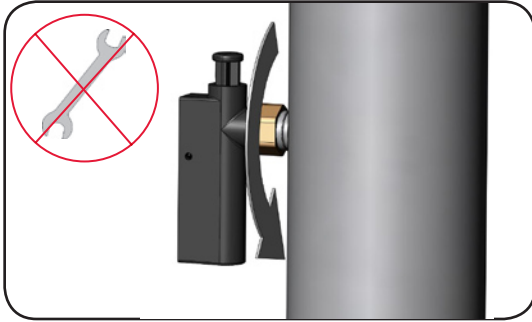

18

Align connections by rotating ring clamp (if equipped) to push lamp plug onto end of lamp.

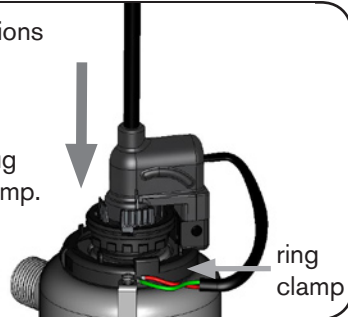

19

Push safety cap into place.



20

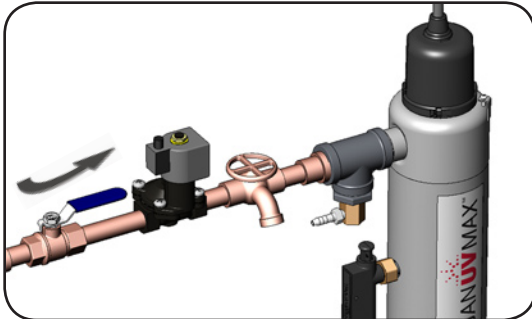

21

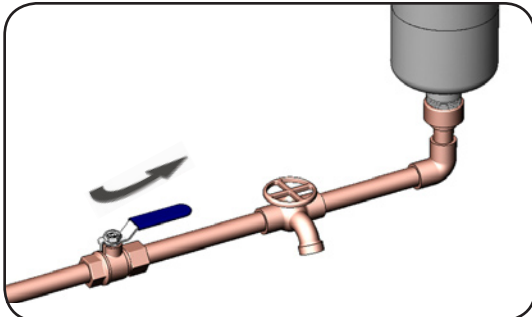

22

Check for leaks.

23

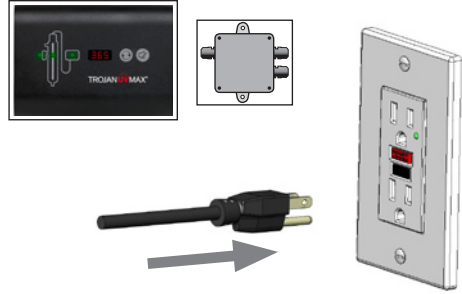

24

*If lamp was replaced and you have a D4, E4, F4 or Plus model:*  
Press and hold Lamp timer reset button for 5 seconds. Display should read 365.



25

Disinfect the water lines. Refer to **Disinfecting the Water Lines** in Installation section.

## WARRANTY

### Our Commitment

To maximize the superior quality of Trojan UV disinfection, each product must be properly sized, installed, and maintained. If you experience difficulty with your Trojan product, our Technical Support Centre is available to help you.

During the applicable warranty period noted below, Trojan will provide warranty coverage, described below, for your product.

### How to Get Help

To obtain help under this warranty, contact the Trojan Technical Support Center at 1-800-265-5774 or by email at residential@trojanuv.com. Please have available the model number, the date of purchase, the name of the dealer from whom you purchased your Trojan product ("the source dealer"), as well as a description of the problem you are experiencing. A Trojan technician will help you troubleshoot the problem and isolate the defective part.

To establish proof of purchase to make a warranty claim, you will need to either retain your original invoice or complete and return a warranty card, which will register you as a product owner in Trojan's database.

### Specific Warranty Coverage

Warranty coverage is specific to the following Trojan products: TrojanUVMax™

#### Ten-Year Limited Warranty for TrojanUVMax™ UV Chamber

Trojan warrants the UV chamber on the TrojanUVMax™ product to be free from defects in material and workmanship for a period of ten (10) years from the date of purchase. During this time, Trojan will repair or replace, at its option, any defective TrojanUVMax™ UV chamber.

Please return the defective part to a Trojan dealer, who will return it to Trojan. Trojan will either make the necessary repairs or, if Trojan determines that a replacement is required, will provide a replacement part. Trojan will then return the part to the dealer. This warranty does not include shipping and handling charges which will be collected from you by the dealer.

Parts repaired or replaced under this ten (10) year warranty will be covered under warranty to the end of the original ten (10) year warranty period. This warranty is also subject to the conditions and limitations outlined under the heading "General Conditions and Limitations" below.

#### Three-Year Limited Warranty for Structural, Hardware and Electrical Components

Trojan warrants the structural, hardware, and electrical components to be free from defects in material and workmanship for a period of three (3) years from the date of purchase. During this time, Trojan will repair or replace, at its option, any defective parts covered by the warranty.

Please return the defective part to a Trojan dealer, who will return it to Trojan. Trojan will either make the necessary repairs or, if Trojan determines that a replacement is required, will provide a replacement part. Trojan will then return the part to the dealer. This warranty does not include shipping and handling charges which will be collected from you by the dealer.

Parts repaired or replaced under this three (3) year warranty will be covered under warranty to the end of the original three (3) year warranty period. This warranty is also subject to the conditions and limitations outlined under the heading "General Conditions and Limitations" below.

#### One-Year Limited Warranty for Lamps, Sleeves and Sensors

Trojan warrants original lamps, sleeves and UV sensors to be free from defects in material and workmanship for a period of one (1) year from the date of purchase. During this time, Trojan will repair or replace, at its option, any defective parts covered by the warranty.

The warranty period for lamps and sleeves may be verified using date codes in addition to purchase receipts and Trojan's database of registered owners. Trojan will advise you whether the defective item needs to be returned to a Trojan dealer for failure analysis. Replacement lamps and sleeves provided under warranty will be sent to your Trojan dealer.

If the UV sensor experiences a problem which Trojan confirms is covered by warranty, please return the sensor to a Trojan dealer who will return it to Trojan. Trojan will either repair or replace the sensor and return the sensor to your dealer.

This warranty on lamps, sleeves and sensors does not include shipping and handling charges which will be collected from you by the dealer. Parts replaced under this one (1) year warranty will be covered under warranty to the end of the original one (1) year warranty period. This warranty is also subject to the conditions and limitations outlined under the heading "General Conditions and Limitations" below.

#### Warranty for Replacement Lamps and Parts

Trojan warrants replacement lamps, purchased for annual routine maintenance, and other parts purchased to repair product components that are no longer covered by the original warranty, to be free from defects in material and workmanship for a period of three (3) months from the date of purchase. During this time, Trojan will repair or replace, at its option, a defective replacement lamp or part free of charge except for shipping and handling charges.

The warranty period on replacement lamps and parts will be verified using date codes and/or purchase receipts. Trojan will advise you whether the defective item needs to be returned to a Trojan dealer for failure analysis. Replacement lamps and parts provided under warranty will be sent to your Trojan dealer.

#### General Conditions and Limitations

None of the above warranties cover damage caused by improper use or maintenance, accidents, acts of God or minor scratches or imperfections that do not materially impair the operation of the product. The warranties also do not cover products that are not installed as outlined in the applicable Owner's Manual.

The limited warranties described above are the only warranties applicable to the Trojan products listed in the "Specific Warranty Coverage" section. These limited warranties outline the exclusive remedy for all claims based on a failure of or defect in any of these products, whether the claim is based on contract, tort (including negligence), strict liability or otherwise. These warranties are in lieu of all other warranties whether written, oral, implied or statutory. Without limitation, no warranty of merchantability or of fitness for a particular purpose shall apply to any of these products.

Trojan does not assume any liability for personal injury or property damage caused by the use or misuse of any of the above products. Trojan shall not in any event be liable for special, incidental, indirect or consequential damages. Trojan's liability shall, in all instances, be limited to repair or replacement of the defective product or part and this liability will terminate upon expiration of the applicable warranty period.



**TROJAN** **UV**<sup>™</sup>  
WATER CONFIDENCE<sup>™</sup>